

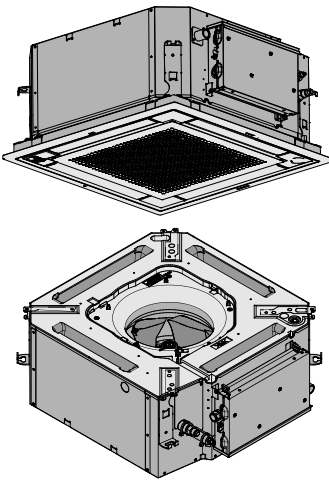

# Installation and operation manual

## Split system air conditioners



**FFA25A2VEB**  
**FFA35A2VEB**  
**FFA50A2VEB**  
**FFA60A2VEB**

Installation and operation manual  
Split system air conditioners

English



## Table of contents

<b>1 About the documentation</b>	<b>3</b>	12.2.3 About the heating operation.....	16
1.1 About this document.....	3	12.2.4 To operate the system .....	16
<b>For the installer</b>	<b>4</b>	12.3 Using the dry program.....	16
<b>2 About the box</b>	<b>4</b>	12.3.1 About the dry program .....	16
2.1 Indoor unit .....	4	12.3.2 To use the dry program.....	16
2.1.1 To remove the accessories from the indoor unit.....	4	12.4 Adjusting the air flow direction.....	16
<b>3 About the units and options</b>	<b>4</b>	12.4.1 About the air flow flap .....	16
3.1 About the indoor unit .....	4	<b>13 Maintenance and service</b>	<b>17</b>
3.2 System layout.....	5	13.1 Cleaning the air filter, suction grille, air outlet and outside panels .....	17
<b>4 Preparation</b>	<b>5</b>	13.1.1 To clean the air filter .....	17
4.1 Preparing installation site .....	5	13.1.2 To clean the suction grille .....	17
4.1.1 Installation site requirements of the indoor unit .....	5	13.1.3 To clean the air outlet and outside panels .....	18
<b>5 Installation</b>	<b>5</b>	13.2 Maintenance after a long stop period .....	18
5.1 Mounting the indoor unit.....	5	13.3 Maintenance before a long stop period .....	18
5.1.1 Precautions when mounting the indoor unit.....	5	13.4 About the refrigerant.....	18
5.1.2 Guidelines when installing the indoor unit.....	5	13.5 After-sales service and warranty .....	19
5.1.3 Guidelines when installing the drain piping.....	6	13.5.1 Warranty period .....	19
5.2 Connecting the refrigerant piping .....	8	13.5.2 Recommended maintenance and inspection .....	19
5.2.1 About connecting the refrigerant piping .....	8	13.5.3 Recommended maintenance and inspection cycles.....	19
5.2.2 Precautions when connecting the refrigerant piping .....	8	13.5.4 Shortened maintenance and replacement cycles .....	19
5.2.3 Guidelines when connecting the refrigerant piping .....	8	<b>14 Troubleshooting</b>	<b>20</b>
5.2.4 Pipe bending guidelines .....	9	14.1 Symptoms that are NOT system malfunctions .....	20
5.2.5 To flare the pipe end .....	9	14.1.1 Symptom: The system does not operate .....	20
5.2.6 To braze the pipe end .....	9	14.1.2 Symptom: The fan strength does not correspond to the setting .....	20
5.2.7 To connect the refrigerant piping to the indoor unit .....	9	14.1.3 Symptom: The fan direction does not correspond to the setting .....	20
5.3 Connecting the electrical wiring.....	9	14.1.4 Symptom: White mist comes out of a unit (Indoor unit).....	21
5.3.1 About connecting the electrical wiring.....	10	14.1.5 Symptom: White mist comes out of a unit (Indoor unit, outdoor unit).....	21
5.3.2 Precautions when connecting the electrical wiring .....	10	14.1.6 Symptom: The user interface display reads "U4" or "U5" and stops, but then restarts after a few minutes..	21
5.3.3 Guidelines when connecting the electrical wiring .....	10	14.1.7 Symptom: Noise of air conditioners (Indoor unit).....	21
5.3.4 Specifications of standard wiring components.....	10	14.1.8 Symptom: Noise of air conditioners (Indoor unit, outdoor unit).....	21
5.3.5 To connect the electrical wiring on the indoor unit.....	10	14.1.9 Symptom: Noise of air conditioners (Outdoor unit).....	21
<b>6 Configuration</b>	<b>11</b>	14.1.10 Symptom: Dust comes out of the unit .....	21
6.1 Field settings .....	11	14.1.11 Symptom: The units can give off odours.....	21
<b>7 Commissioning</b>	<b>11</b>	14.1.12 Symptom: The outdoor unit fan does not spin .....	21
7.1 Overview: Commissioning.....	11	14.1.13 Symptom: The display shows "88".....	21
7.2 Precautions when commissioning .....	11	14.1.14 Symptom: The compressor in the outdoor unit does not stop after a short heating operation .....	21
7.3 Checklist before commissioning.....	12	<b>15 Relocation</b>	<b>21</b>
7.4 To perform a test run.....	12	<b>16 Disposal</b>	<b>21</b>
7.5 Error codes when performing a test run .....	13	<b>1 About the documentation</b>	
<b>8 Disposal</b>	<b>13</b>	<b>1.1 About this document</b>	
<b>9 Technical data</b>	<b>13</b>	<b>Target audience</b>	
9.1 Piping diagram: Indoor unit .....	13	Authorised installers + end users	
9.2 Wiring diagram .....	14	<b>INFORMATION</b>	
<b>For the user</b>	<b>15</b>	This appliance is intended to be used by expert or trained users in shops, in light industry, and on farms, or for commercial and household use by lay persons.	
<b>10 About the system</b>	<b>15</b>	<b>Documentation set</b>	
10.1 System layout.....	15	This document is part of a documentation set. The complete set consists of:	
<b>11 User interface</b>	<b>15</b>		
<b>12 Operation</b>	<b>15</b>		
12.1 Operation range .....	15		
12.2 Operating the system .....	16		
12.2.1 About operating the system .....	16		
12.2.2 About cooling, heating, fan only, and automatic operation .....	16		

## 2 About the box

- **General safety precautions:**
  - Safety instructions that you must read before installing
  - Format: Paper (in the box of the indoor unit)
- **Indoor unit installation and operation manual:**
  - Installation and operation instructions
  - Format: Paper (in the box of the indoor unit)
- **Installer and user reference guide:**
  - Preparation of the installation, good practices, reference data,...
  - Detailed step-by-step instructions and background information for basic and advanced usage
  - Format: Digital files on <http://www.daikineurope.com/support-and-manuals/product-information/>

Latest revisions of the supplied documentation may be available on the regional Daikin website or via your dealer.

The original documentation is written in English. All other languages are translations.

### Technical engineering data

- A **subset** of the latest technical data is available on the regional Daikin website (publicly accessible).
- The **full set** of latest technical data is available on the Daikin extranet (authentication required).

## For the installer

## 2 About the box

### 2.1 Indoor unit

#### 2.1.1 To remove the accessories from the indoor unit

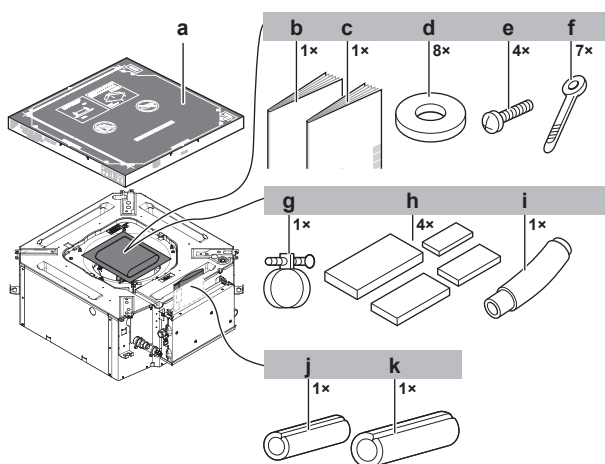

- a Paper pattern for installation (upper part of packing)
- b General safety precautions
- c Indoor unit installation and operation manual
- d Washers for hanger bracket
- e Screws
- f Cable ties
- g Metal clamp
- h Sealing pads: Large (drain pipe), medium 1 (gas pipe), medium 2 (liquid pipe), small (electrical wiring)
- i Drain hose
- j Insulation piece: Small (liquid pipe)
- k Insulation piece: Large (gas pipe)

## 3 About the units and options

### 3.1 About the indoor unit

Use the system in the following temperature and humidity ranges for safe and effective operation.

For combination with R410A outdoor unit, refer to the following table:

Outdoor units		Cooling	Heating
RR71~125	Outdoor temperature	-15~46°C DB	—
	Indoor temperature	18~37°C DB 12~28°C WB	—
RQ71~125	Outdoor temperature	-5~46°C DB	-9~21°C DB -10~15°C WB
	Indoor temperature	18~37°C DB 12~28°C WB	10~27°C DB
RXS25~60	Outdoor temperature	-10~46°C DB	-15~24°C DB -16~18°C WB
	Indoor temperature	18~32°C DB	10~30°C DB
2MXS50	Outdoor temperature	10~46°C DB	-15~24°C DB -16~18°C WB
	Indoor temperature	18~32°C DB	10~30°C DB
3MXS40~68 4MXS68~80 5MXS90	Outdoor temperature	-10~46°C DB	-15~24°C DB -16~18°C WB
	Indoor temperature	18~32°C DB	10~30°C DB
	Indoor temperature	18~32°C DB	10~30°C DB
RZQG71~140	Outdoor temperature	-15~50°C DB	-19~21°C DB -20~15.5°C WB
	Indoor temperature	18~37°C DB 12~28°C WB	10~27°C DB
RZQSG71~140	Outdoor temperature	-15~46°C DB	-14~21°C DB -15~15.5°C WB
	Indoor temperature	20~37°C DB 14~28°C WB	10~27°C DB
RZQ200~250	Outdoor temperature	-5~46°C DB	-14~21°C DB -15~15°C WB
	Indoor temperature	20~37°C DB 14~28°C WB	10~27°C DB

For combination with R32 outdoor unit, refer to the following table:

Outdoor units		Cooling	Heating
RXM25~60	Outdoor temperature	-10~46°C DB	-15~24°C DB -16~18°C WB
	Indoor temperature	18~32°C DB	10~30°C DB
2MXM50 3MXM40~68 4MXM68~80 5MXM90	Outdoor temperature	-10~46°C DB	-15~24°C DB -16~18°C WB
	Indoor temperature	18~32°C DB	10~30°C DB
RZAG71~140	Outdoor temperature	-20~52°C DB	-19.5~21°C DB -20~15.5°C WB
	Indoor temperature	18~37°C DB 12~28°C WB	10~27°C DB
RZASG71~140	Outdoor temperature	-15~46°C DB	-14~21°C DB -15~15.5°C WB
	Indoor temperature	20~37°C DB 14~28°C WB	10~27°C DB
Indoor humidity		≤80% <sup>(a)</sup>	

(a) To avoid condensation and water dripping out of the unit. If the temperature or the humidity is beyond these conditions, safety devices may be put in action and the air conditioner may not operate.

### 3.2 System layout

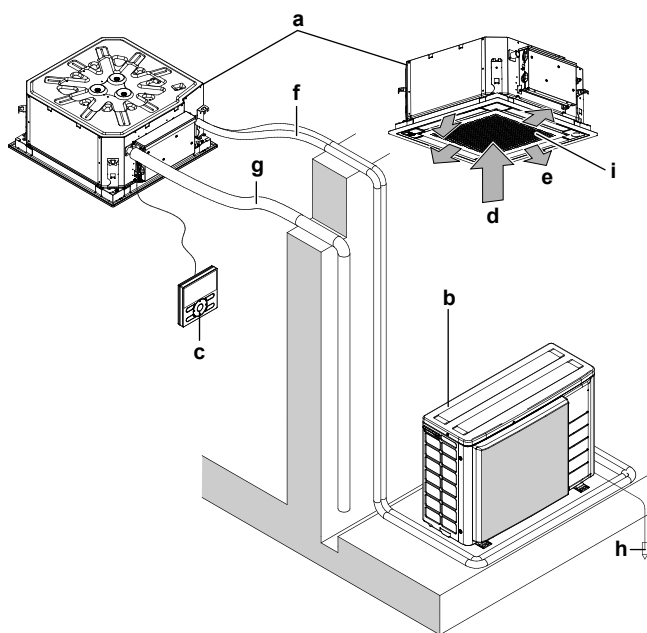

- a Indoor unit
- b Outdoor unit
- c User interface
- d Suction air
- e Discharge air
- f Refrigerant piping + interconnection cable
- g Drain pipe
- h Earth wiring
- i Suction grille and air filter

## 4 Preparation

### 4.1 Preparing installation site

#### 4.1.1 Installation site requirements of the indoor unit



#### INFORMATION

The sound pressure level is less than 70 dBA.



#### CAUTION

Appliance not accessible to the general public, install it in a secured area, protected from easy access.

This unit, both indoor and outdoor, is suitable for installation in a commercial and light industrial environment.

- **Spacing.** Mind the following requirements:

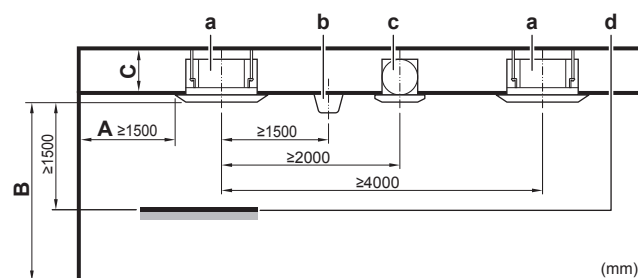

- A Minimum distance to the wall
- B Minimum and maximum distance to the floor (see below)
- C **≥295 mm:** In case of installation with BYFQ60B  
**≥300 mm:** In case of installation with BYFQ60C
- a Indoor unit
- b Lighting (the figure shows ceiling-mounted lighting, but recessed lighting is also allowed)
- c Air fan
- d Static volume (example: table)

- **Minimum and maximum distance to the floor:**

- Minimum: 2.5 m to avoid accidental touching.
- Maximum: Depends on the air flow directions and the capacity class. Also make sure the "Ceiling height" field setting corresponds with the actual situation. See Field settings.

## 5 Installation

### 5.1 Mounting the indoor unit

#### 5.1.1 Precautions when mounting the indoor unit



#### INFORMATION

Also read the precautions and requirements in the following chapters:

- General safety precautions
- Preparation

#### 5.1.2 Guidelines when installing the indoor unit



#### INFORMATION

**Optional equipment.** When installing optional equipment, also read the installation manual of the optional equipment. Depending on the field conditions, it might be easier to install the optional equipment first.

## 5 Installation

- **Decoration panel.** Install the decoration panel always **after** installing the unit.
- **Ceiling strength.** Check whether the ceiling is strong enough to support the weight of the unit. If there is a risk, reinforce the ceiling before installing the unit.

- For existing ceilings, use anchors.
- For new ceilings, use sunken inserts, sunken anchors or other field supplied parts.

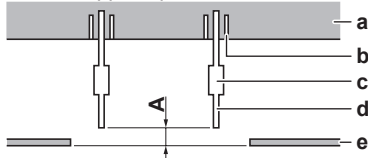

- A** 50~100 mm  
**a** Ceiling slab  
**b** Anchor  
**c** Long nut or turnbuckle  
**d** Suspension bolt  
**e** Suspended ceiling

- **Suspension bolts.** Use M8~M10 suspension bolts for installation. Attach the hanger bracket to the suspension bolt. Fix it securely using a nut and washer from the upper and lower sides of the hanger bracket.

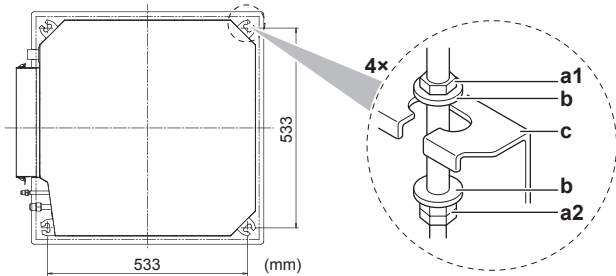

- a1** Nut (field supply)  
**a2** Double nut (field supply)  
**b** Washer (accessories)  
**c** Hanger bracket (attached to the unit)

- **Paper pattern for installation** (upper part of the packing). Use the paper pattern to determine the correct horizontal positioning. It contains the necessary dimensions and centers. You can attach the paper pattern to the unit.

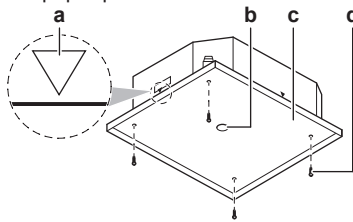

- a** Centre of the unit  
**b** Centre of the ceiling opening  
**c** Paper pattern for installation (upper part of the packing)  
**d** Screws (accessories)

- **Ceiling opening and unit:**

- Make sure the ceiling opening is within the following limits:

**Minimum:** 585 mm to be able to fit the unit.

**Maximum:** 660 mm in case of installation with BYFQ60B and 595 mm in case of installation with BYFQ60C ensure enough overlapping between the decoration panel and the suspended ceiling. If the ceiling opening is larger, add extra ceiling material.

- Make sure the unit and its hanger brackets (suspension) are centered within the ceiling opening.

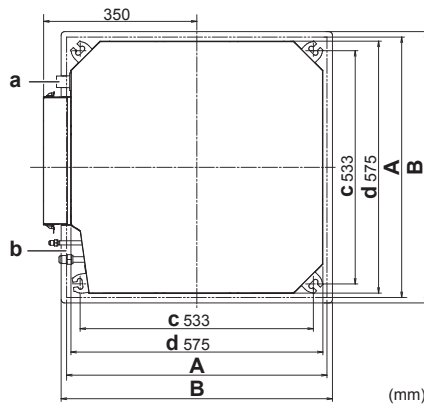

- A** 585~660 mm: In case of installation with BYFQ60B  
**585~595 mm:** In case of installation with BYFQ60C  
**B** 700 mm: In case of installation with BYFQ60B  
**620 mm:** In case of installation with BYFQ60C  
**a** Drain piping  
**b** Refrigerant piping  
**c** Hanger bracket pitch (suspension)  
**d** Unit

	Then		
	If A	B	C
	BYFQ60B		
	585 mm (= min.)	5 mm	57.5 mm
	660 mm (= max.)	42.5 mm	20 mm
	BYFQ60C		
	585 mm (= min.)	5 mm	17.5 mm
	595 mm (= max.)	10 mm	12.5 mm

- A** Ceiling opening  
**B** Distance between the unit and the ceiling opening  
**C** Overlap between the decoration panel and the suspended ceiling

- **Level.** Make sure the unit is level at all 4 corners using a level or a water-filled vinyl tube.

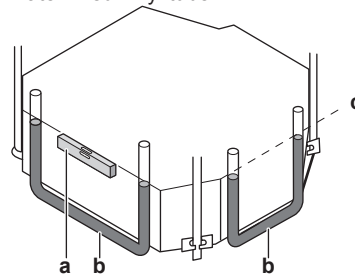

- a** Level  
**b** Vinyl tube  
**c** Water level



### NOTICE

Do NOT install the unit tilted. **Possible consequence:** If the unit is tilted against the direction of the condensate flow (the drain piping side is raised), the float switch might malfunction and cause water to drip.

### 5.1.3 Guidelines when installing the drain piping

Make sure condensation water can be evacuated properly. This involves:

- General guidelines
- Connecting the drain piping to the indoor unit

- Checking for water leaks

## General guidelines

- **Pipe length.** Keep drain piping as short as possible.
- **Pipe size.** Keep the pipe size equal to or greater than that of the connecting pipe (vinyl pipe of 25 mm nominal diameter and 32 mm outer diameter).

- **Slope.** Make sure the drain piping slopes down (at least 1/100) to prevent air from being trapped in the piping. Use hanging bars as shown.

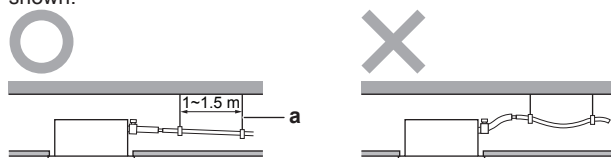

- a Hanging bar
- O Allowed
- X Not allowed

- **Condensation.** Take measures against condensation. Insulate the complete drain piping in the building.

- **Rising piping.** If necessary to make the slope possible, you can install rising piping.

- Drain hose inclination: 0~75 mm to avoid stress on the piping and to avoid air bubbles.
- Rising piping: ≤300 mm from the unit, ≤630~675 mm (depending on the decoration panel used) perpendicular to the unit.

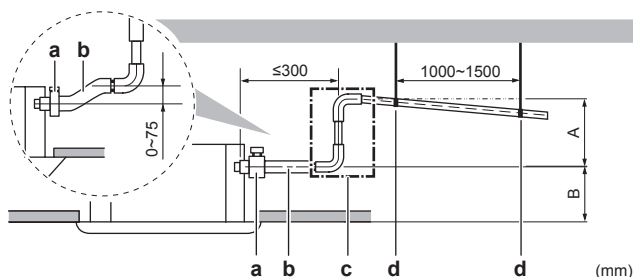

- A ≤645 mm: In case of installation with BYFQ60B
- ≤630 mm: In case of installation with BYFQ60C
- B 205 mm: In case of installation with BYFQ60B
- 220 mm: In case of installation with BYFQ60C
- a Metal clamp (accessory)
- b Drain hose (accessory)
- c Rising drain piping (vinyl pipe of 25 mm nominal diameter and 32 mm outer diameter) (field supply)
- d Hanging bars (field supply)

- **Combining drain pipes.** You can combine drain pipes. Make sure to use drain pipes and T-joints with the correct gauge for the operating capacity of the units.

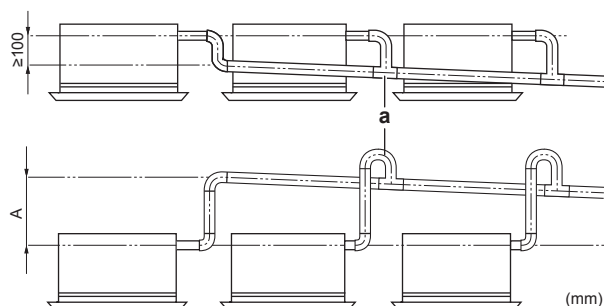

- A ≤645 mm: In case of installation with BYFQ60B
- ≤630 mm: In case of installation with BYFQ60C
- a T-joint

## To connect the drain piping to the indoor unit



### NOTICE

Incorrect connection of the drain hose might cause leaks, and damage the installation space and surroundings.

- 1 Push the drain hose as far as possible over the drain pipe connection.
- 2 Tighten the metal clamp until the screw head is less than 4 mm from the metal clamp part.
- 3 Check for water leaks (see "To check for water leaks" on page 7).
- 4 Install the insulation piece (drain pipe).
- 5 Wind the large sealing pad (= insulation) around the metal clamp and drain hose, and fix it with cable ties.
- 6 Connect the drain piping to the drain hose.

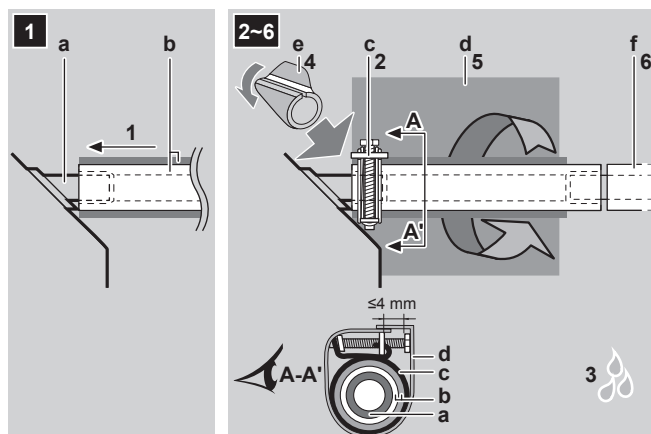

- a Drain pipe connection (attached to the unit)
- b Drain hose (accessory)
- c Metal clamp (accessory)
- d Large sealing pad (accessory)
- e Insulation piece (drain pipe) (accessory)
- f Drain piping (field supply)

## To check for water leaks

The procedure differs depending on whether electrical wiring is already finished. When electrical wiring is not finished yet, you need to temporarily connect the user interface and power supply to the unit.

### When electrical wiring is not finished yet

- 1 Temporarily connect electrical wiring.
  - Remove the control box cover (a).
  - Connect the single-phase power supply (50 Hz, 230 V) to connections No. 1 and No. 2 on the terminal block for power supply (d) and earth (c).
  - Reattach the control box cover (a).

## 5 Installation

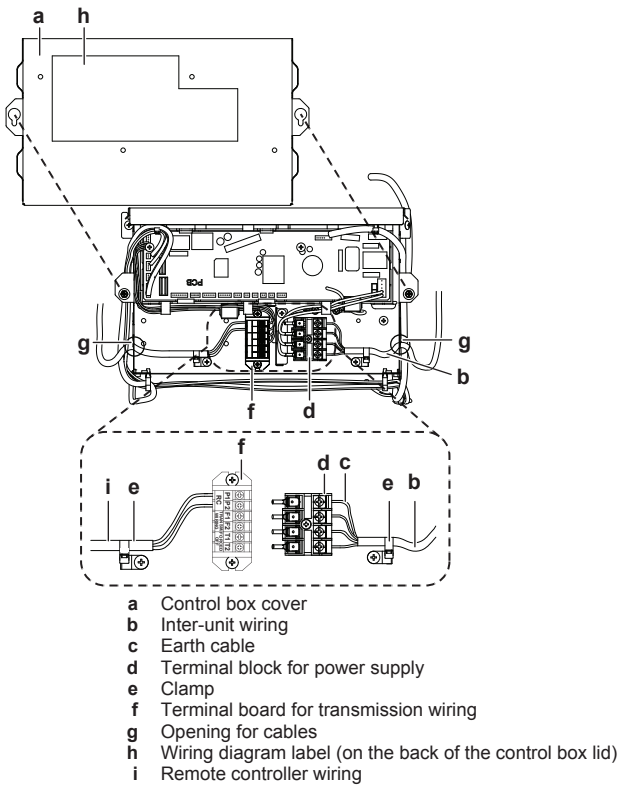

- 2 Turn ON the power.
- 3 Start cooling operation (see "7.4 To perform a test run" on page 12).
- 4 Gradually pour approximately 1 l of water through the air discharge outlet, and check for leaks.

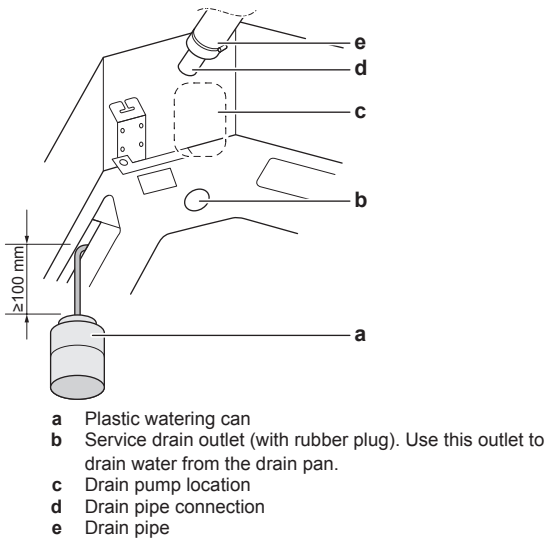

- 5 Turn OFF the power.
- 6 Disconnect the electrical wiring.
  - Remove the control box cover.
  - Disconnect the power supply and earth.
  - Reattach the control box cover.

### When electrical wiring is finished already

- 1 Start cooling operation (see "7.4 To perform a test run" on page 12).
- 2 Gradually pour approximately 1 l of water through the air discharge outlet, and check for leaks (see When electrical wiring is not finished yet).

## 5.2 Connecting the refrigerant piping



**DANGER: RISK OF BURNING**

### 5.2.1 About connecting the refrigerant piping

#### Before connecting the refrigerant piping

Make sure the outdoor and indoor unit are mounted.

#### Typical workflow

Connecting the refrigerant piping involves:

- Connecting the refrigerant piping to the outdoor unit
- Connecting the refrigerant piping to the indoor unit
- Insulating the refrigerant piping
- Keeping in mind the guidelines for:
  - Pipe bending
  - Flaring pipe ends
  - Brazing
  - Using the stop valves

### 5.2.2 Precautions when connecting the refrigerant piping



#### INFORMATION

Also read the precautions and requirements in the following chapters:

- General safety precautions
- Preparation



**DANGER: RISK OF BURNING**

### 5.2.3 Guidelines when connecting the refrigerant piping

Take the following guidelines into account when connecting pipes:

- Coat the flare inner surface with ether oil or ester oil when connecting a flare nut. Tighten 3 or 4 turns by hand, before tightening firmly.

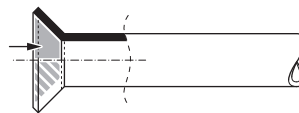

- Always use 2 wrenches together when loosening a flare nut.
- Always use a spanner and torque wrench together to tighten the flare nut when connecting the piping. This to prevent nut cracking and leaks.

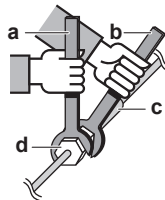

- a Torque wrench  
 b Spanner  
 c Piping union  
 d Flare nut



Piping size (mm)	Tightening torque (N·m)	Flare dimensions (A) (mm)	Flare shape (mm)
Ø6.4	15~17	8.7~9.1	
Ø9.5	33~39	12.8~13.2	
Ø12.7	50~60	16.2~16.6	

## 5.2.4 Pipe bending guidelines

Use a pipe bender for bending. All pipe bends should be as gentle as possible (bending radius should be 30~40 mm or larger).

## 5.2.5 To flare the pipe end



### CAUTION

- Incomplete flaring may cause refrigerant gas leakage.
- Do NOT re-use flares. Use new flares to prevent refrigerant gas leakage.
- Use flare nuts that are included with the unit. Using different flare nuts may cause refrigerant gas leakage.

- 1 Cut the pipe end with a pipe cutter.
- 2 Remove burrs with the cut surface facing down so that the chips do not enter the pipe.

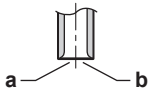

- a Cut exactly at right angles.
- b Remove burrs.

- 3 Remove the flare nut from the stop valve and put the flare nut on the pipe.
- 4 Flare the pipe. Set exactly at the position as shown in the following illustration.

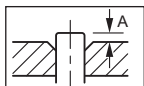

	Flare tool for R410A or R32 (clutch type)	Conventional flare tool	
		Clutch type (Ridgid-type)	Wing nut type (Imperial-type)
A	0~0.5 mm	1.0~1.5 mm	1.5~2.0 mm

- 5 Check that the flaring is properly made.

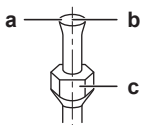

- a Flare's inner surface must be flawless.
- b The pipe end must be evenly flared in a perfect circle.
- c Make sure the flare nut is fitted.

## 5.2.6 To braze the pipe end

The indoor unit and outdoor unit have flare connections. Connect both ends without brazing. If brazing should be needed, take the following into account:

- When brazing, blow through with nitrogen to prevent creation of large quantities of oxidised film on the inside of the piping. This film adversely affects valves and compressors in the refrigerating system and prevents proper operation.
- Set the nitrogen pressure to 20 kPa (0.2 bar) (just enough so it can be felt on the skin) with a pressure-reducing valve.

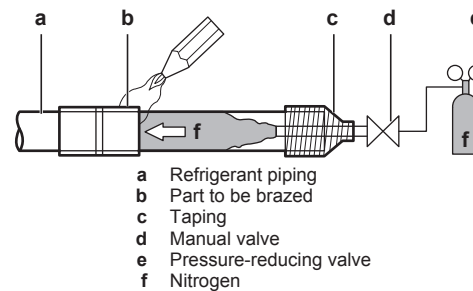

- Do NOT use anti-oxidants when brazing pipe joints. Residue can clog pipes and break equipment.
- Do NOT use flux when brazing copper-to-copper refrigerant piping. Use phosphor copper brazing filler alloy (BCuP), which does not require flux. Flux has an extremely harmful influence on refrigerant piping systems. For instance, if chlorine based flux is used, it will cause pipe corrosion or, in particular, if the flux contains fluorine, it will deteriorate the refrigerant oil.

## 5.2.7 To connect the refrigerant piping to the indoor unit



### WARNING: FLAMMABLE MATERIAL

The R32 refrigerant (if applicable) in this unit is mildly flammable.<sup>(a)</sup>

- (a) Refer to the outdoor unit specifications for the type of refrigerant to be used.

- **Pipe length.** Keep refrigerant piping as short as possible.
- **Flare connections.** Connect refrigerant piping to the unit using flare connections.
- **Insulation.** Insulate the refrigerant piping on the indoor unit as follows:

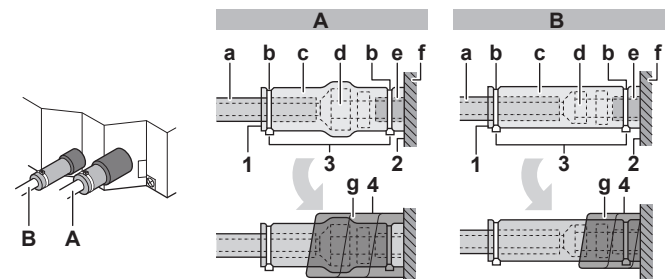

- A Gas piping
- B Liquid piping

- a Insulation material (field supply)
- b Cable tie (accessory)
- c Insulation pieces: Large (gas pipe), small (liquid pipe) (accessories)
- d Flare nut (attached to the unit)
- e Refrigerant pipe connection (attached to the unit)
- f Unit
- g Sealing pads: Medium 1 (gas pipe), medium 2 (liquid pipe) (accessories)

- 1 Turn up the seams of the insulation pieces.
- 2 Attach to the base of the unit.
- 3 Tighten the cable ties on the insulation pieces.
- 4 Wrap the sealing pad from the base of the unit to the top of the flare nut.



### NOTICE

Make sure to insulate all refrigerant piping. Any exposed piping might cause condensation.

## 5.3 Connecting the electrical wiring



### DANGER: RISK OF ELECTROCUTION

## 5 Installation



### WARNING

ALWAYS use multicore cable for power supply cables.



### WARNING

If the supply cord is damaged, it must be replaced by the manufacturer, its service agent or similarly qualified persons in order to avoid a hazard.

### 5.3.1 About connecting the electrical wiring

#### Typical workflow

Connecting the electrical wiring typically consists of the following stages:

- 1 Making sure the power supply system complies with the electrical specifications of the units.
- 2 Connecting the electrical wiring to the outdoor unit.
- 3 Connecting the electrical wiring to the indoor unit.
- 4 Connecting the main power supply.

### 5.3.2 Precautions when connecting the electrical wiring



#### INFORMATION

Also read the precautions and requirements in the following chapters:

- General safety precautions
- Preparation



#### DANGER: RISK OF ELECTROCUTION



### WARNING

ALWAYS use multicore cable for power supply cables.



### WARNING

If the supply cord is damaged, it must be replaced by the manufacturer, its service agent or similarly qualified persons in order to avoid a hazard.

### 5.3.3 Guidelines when connecting the electrical wiring

#### Tightening torques

Wiring	Screw size	Tightening torque (N·m)
Interconnection cable (indoor↔outdoor)	M4	1.18~1.44
User interface cable	M3.5	0.79~0.97

### 5.3.4 Specifications of standard wiring components

Component	Specification
Interconnection cable (indoor↔outdoor)	Minimum cable section of 2.5 mm <sup>2</sup> and applicable for 230 V
User interface cable	Vinyl cords with 0.75 to 1.25 mm <sup>2</sup> sheath or cables (2-core wires) Maximum 500 m

### 5.3.5 To connect the electrical wiring on the indoor unit



#### NOTICE

- Follow the wiring diagram (delivered with the unit, located at the inside of the service cover).
- For instructions on how to connect the decoration panel and the sensor kit, see the wiring instruction sheet (delivered with the unit, inside the accessory bag).
- Make sure the electrical wiring does NOT obstruct proper reattachment of the service cover.

It is important to keep the power supply and the transmission wiring separated from each other. In order to avoid any electrical interference the distance between both wiring should always be at least 50 mm.



#### NOTICE

Be sure to keep the power line and transmission line apart from each other. Transmission wiring and power supply wiring may cross, but may not run parallel.

- 1 Remove the service cover.
  - 2 **User interface cable:** Route the cable through the frame, connect the cable to the terminal block, and fix the cable with a cable tie.
  - 3 **Interconnection cable (indoor↔outdoor):** Route the cable through the frame, connect the cable to the terminal block (make sure the numbers match with the numbers on the outdoor unit, and connect the earth wire), and fix the cable with a cable tie.
  - 4 Divide the small sealing (accessory) and wrap it around the cables to prevent water from entering the unit. Seal all gaps to prevent small animals from entering the system.
- WARNING**
- Provide adequate measures to prevent that the unit can be used as a shelter by small animals. Small animals that make contact with electrical parts can cause malfunctions, smoke or fire.
- 5 Reattach the service cover.
- Following installation is for pair type or multi-system. For more installation options, see the Installer reference guide of the indoor unit.

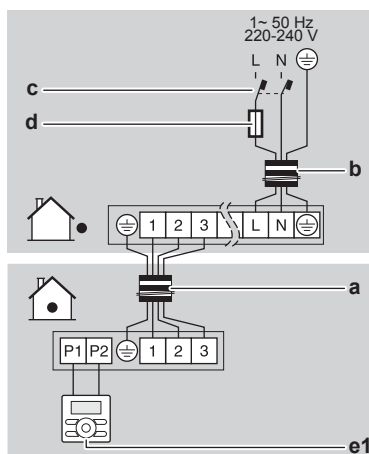

- a Interconnection cable
- b Power supply cable
- c Earth leakage circuit breaker
- d Fuse
- e1 Main user interface

## 6 Configuration

### 6.1 Field settings

Make the following field settings so that they correspond with the actual installation setup and with the needs of the user:

- Ceiling height
- Air flow direction
- Air volume when thermostat control is OFF
- Time to clean air filter

#### Setting: Ceiling height

This setting must correspond with the actual distance to the floor, capacity class and air flow directions.

- For 3-way and 4-way air flows (which require an optional blocking pad kit), see the installation manual of the optional blocking pad kit.
- For all-round air flow, use the table below.

If the distance to the floor is (m)	Then <sup>1</sup>		
	M	C1	C2
≤2.7	13 (23)	0	01
2.7<x≤3.0			02
3.0<x≤3.5			03

#### Setting: Air flow direction

This setting must correspond with the actual used air flow directions. See the installation manual of the optional blocking pad kit and the manual of the user interface.

Default: 01 (= all-round air flow)

#### Example:

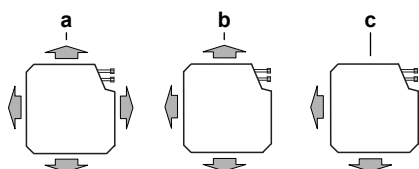

- a All-round air flow
- b 3-way air flow (1 air outlet closed) (optional blocking pad kit required)
- c 2-way air flow (2 air outlets closed) (optional blocking pad kit required)

#### Setting: Air volume when thermostat control is OFF

This setting must correspond with the needs of the user. It determines the fan speed of the indoor unit during thermostat OFF condition.

- 1 If you have set the fan to operate, set the air volume speed:

<sup>(1)</sup> Field settings are defined as follows:

- **M**: Mode number – **First number**: for group of units – **Number between brackets**: for individual unit
- **C1**: First code number
- **C2**: Second code number
- **■**: Default

<sup>(2)</sup> Fan speed:

- **LL**: Low fan speed
- **Setup volume**: The fan speed corresponds to the speed the user has set (low, medium, high) using the fan speed button on the user interface.
- **Monitoring 1, 2**: The fan is OFF, but runs for a short time every 6 minutes to detect the room temperature by Low fan speed (1) or by Setup volume (2).

	If you want		Then <sup>1</sup>		
	General	2MX+3MX +4MX+5MX	M	C1	C2
During cooling operation	LL <sup>2</sup>		12	6	01
	Setup volume <sup>2</sup>		(22)		02
During heating operation	LL <sup>2</sup>	Monitoring 1 <sup>2</sup>	12	3	01
	Setup volume <sup>2</sup>	Monitoring 2 <sup>2</sup>	(22)		02

#### Setting: Time to clean air filter

This setting must correspond with the air contamination in the room. It determines the interval at which the **TIME TO CLEAN AIR FILTER** notification is displayed on the user interface. When using a wireless user interface, you must also set the address (see the installation manual of the user interface).

If you want an interval of... (air contamination)	Then <sup>1</sup>		
	M	C1	C2
±2500 h (light)	10 (20)	0	01
±1250 h (heavy)			02
No notification		3	02

## 7 Commissioning



#### NOTICE

NEVER operate the unit without thermistors and/or pressure sensors/switches. Burning of the compressor might result.

### 7.1 Overview: Commissioning

This chapter describes what you have to do and know to commission the system after it is installed.

#### Typical workflow

Commissioning typically consists of the following stages:

- 1 Checking the "Checklist before commissioning".
- 2 Performing a test run for the system.

### 7.2 Precautions when commissioning



#### INFORMATION

During the first running period of the unit, the required power may be higher than stated on the nameplate of the unit. This phenomenon is caused by the compressor, that needs a continuous run time of 50 hours before reaching smooth operation and stable power consumption.

## 7 Commissioning

### NOTICE

Before starting up the system, the unit **MUST** be energised for at least 6 hours. The crankcase heater needs to heat up the compressor oil to avoid oil shortage and compressor breakdown during startup.

### NOTICE

NEVER operate the unit without thermistors and/or pressure sensors/switches. Burning of the compressor might result.

### NOTICE

Do **NOT** operate the unit until the refrigerant piping is complete (when operated this way, the compressor will break).

### NOTICE

**Cooling operation mode.** Perform the test run in cooling operation mode so that stop valves failing to open can be detected. Even if the user interface was set to heating operation mode, the unit will run in cooling operation mode during 2-3 minutes (although the user interface will display the heating icon), and then automatically switch to heating operation mode.

### NOTICE

If you cannot operate the unit in test run, see "[7.5 Error codes when performing a test run](#)" on page 13.

### WARNING

If the panels on the indoor units are not installed yet, make sure to power OFF the system after finishing the test run. To do so, turn OFF operation via the user interface. Do **NOT** stop operation by turning OFF the circuit breakers.

## 7.3 Checklist before commissioning

Do **NOT** operate the system before the following checks are OK:

<input type="checkbox"/>	You read the complete installation instructions, as described in the <b>installer reference guide</b> .
<input type="checkbox"/>	The <b>indoor units</b> are properly mounted.
<input type="checkbox"/>	In case a wireless user interface is used: The <b>indoor unit decoration panel</b> with infrared receiver is installed.
<input type="checkbox"/>	The <b>outdoor unit</b> is properly mounted.
<input type="checkbox"/>	There are <b>NO missing phases</b> or <b>reversed phases</b> .
<input type="checkbox"/>	The system is properly <b>earthed</b> and the earth terminals are tightened.
<input type="checkbox"/>	The <b>fuses</b> or locally installed protection devices are installed according to this document, and have not been bypassed.
<input type="checkbox"/>	The <b>power supply voltage</b> matches the voltage on the identification label of the unit.
<input type="checkbox"/>	There are <b>NO loose connections</b> or damaged electrical components in the switch box.
<input type="checkbox"/>	The <b>insulation resistance</b> of the compressor is OK.
<input type="checkbox"/>	There are <b>NO damaged components</b> or <b>squeezed pipes</b> on the inside of the indoor and outdoor units.
<input type="checkbox"/>	There are <b>NO refrigerant leaks</b> .
<input type="checkbox"/>	The correct pipe size is installed and the <b>pipes</b> are properly insulated.



The **stop valves** (gas and liquid) on the outdoor unit are fully open.

## 7.4 To perform a test run

This task is only applicable when using the BRC1E52 or BRC1E53 user interface. When using any other user interface, see the installation manual or service manual of the user interface.



### NOTICE

Do not interrupt the test run.



### INFORMATION

**Backlight.** To perform an ON/OFF action on the user interface, the backlight does not need to be lit. For any other action, it needs to be lit first. The backlight is lit for  $\pm 30$  seconds when you press a button.

- 1 Perform introductory steps.

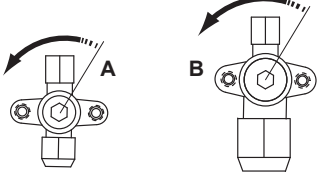
#	Action
1	Open the liquid stop valve (A) and gas stop valve (B) by removing the stem cap and turning counterclockwise with a hex wrench until it stops. 
2	Close the service cover to prevent electric shocks.
3	Turn ON power for at least 6 hours before starting operation to protect the compressor.
4	On the user interface, set the unit to cooling operation mode.

- 2 Start the test run

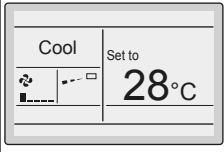
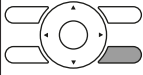
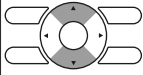
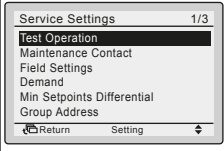
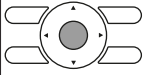
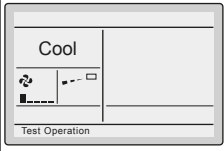
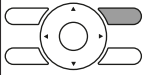
#	Action	Result
1	Go to the home menu.	
2	Press at least 4 seconds. 	The Service Settings menu is displayed.
3	Select Test Operation. 	
4	Press. 	Test Operation is displayed on the home menu. 
5	Press within 10 seconds. 	Test run starts.

- 3 Check operation for 3 minutes.
- 4 Check operation of the airflow direction.

#	Action	Result
1	Press. 	
2	Select Position 0. 	
3	Change the position. 	If the airflow flap of the indoor unit moves, operation is OK. If not, operation is not OK.
4	Press. 	The home menu is displayed.

- 5 Stop the test run.

#	Action	Result
1	Press at least 4 seconds. 	The Service Settings menu is displayed.
2	Select Test Operation. 	
3	Press. 	The unit returns to normal operation, and the home menu is displayed.

## 7.5 Error codes when performing a test run

If the installation of the outdoor unit has NOT been done correctly, the following error codes may be displayed on the user interface:

Error code	Possible cause
Nothing displayed (the currently set temperature is not displayed)	<ul style="list-style-type: none"> <li>The wiring is disconnected or there is a wiring error (between power supply and outdoor unit, between outdoor unit and indoor units, between indoor unit and user interface).</li> <li>The fuse on the outdoor or indoor unit PCB has blown.</li> </ul>
E3, E4 or L8	<ul style="list-style-type: none"> <li>The stop valves are closed.</li> <li>The air inlet or air outlet is blocked.</li> </ul>
E7	<p>There is a missing phase in case of three-phase power supply units.</p> <p><b>Note:</b> Operation will be impossible. Turn OFF the power, recheck the wiring, and switch two of the three electrical wires.</p>
L4	The air inlet or air outlet is blocked.
U0	The stop valves are closed.

Error code	Possible cause
U2	<ul style="list-style-type: none"> <li>There is a voltage imbalance.</li> <li>There is a missing phase in case of three-phase power supply units. <b>Note:</b> Operation will be impossible. Turn OFF the power, recheck the wiring, and switch two of the three electrical wires.</li> </ul>
U4 or UF	The inter-unit branch wiring is not correct.
UA	The outdoor and indoor unit are incompatible.

## 8 Disposal



### NOTICE

Do not try to dismantle the system yourself: the dismantling of the system, treatment of the refrigerant, oil and other parts must comply with applicable legislation. Units must be treated at a specialized treatment facility for reuse, recycling and recovery.

## 9 Technical data

- A **subset** of the latest technical data is available on the regional Daikin website (publicly accessible).
- The **full set** of latest technical data is available on the Daikin extranet (authentication required).



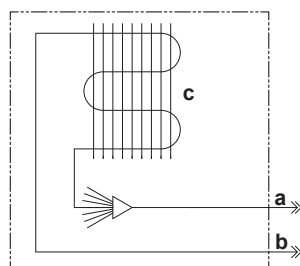











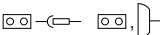

### 9.1 Piping diagram: Indoor unit



- a Liquid pipe connection
- b Gas pipe connection
- c Heat exchanger

## 9 Technical data

### 9.2 Wiring diagram

Unified Wiring Diagram Legend			
For applied parts and numbering refer to the wiring diagram sticker supplied on the unit. Part numbering is realized by Arabic numbers in ascending order for each part and is represented in the overview below by symbol ** in the part code.			
	: CIRCUIT BREAKER		: PROTECTIVE EARTH
	: CONNECTION		: PROTECTIVE EARTH (SCREW)
	: CONNECTOR		: RECTIFIER
	: EARTH		: RELAY CONNECTOR
	: FIELD WIRING		: SHORT CIRCUIT CONNECTOR
	: FUSE		: TERMINAL
	: INDOOR UNIT		: TERMINAL STRIP
	: OUTDOOR UNIT		: WIRE CLAMP
BLK : BLACK	GRN : GREEN	PNK : PINK	WHT : WHITE
BLU : BLUE	GRY : GREY	PRP,PPL : PURPLE	YLW : YELLOW
BRN : BROWN	ORG : ORANGE	RED : RED	
A*P	: PRINTED CIRCUIT BOARD	PS	: SWITCHING POWER SUPPLY
BS*	: PUSH BUTTON ON / OFF, OPERATION SWITCH	PTC*	: THERMISTOR PTC
BZ, H*O	: BUZZER	Q*	: INSULATED GATE BIPOLAR TRANSISTOR (IGBT)
C*	: CAPACITOR	Q*DI	: EARTH LEAK CIRCUIT BREAKER
AC*, CN*, E*, HA*, HE, HL*, HN*, HR*, MR*_A, MR*_B, S*, U, V, W, X*A	: CONNECTION, CONNECTOR	Q*L	: OVERLOAD PROTECTOR
D*, V*D	: DIODE	Q*M	: THERMO SWITCH
DB*	: DIODE BRIDGE	R*	: RESISTOR
DS*	: DIP SWITCH	R*T	: THERMISTOR
E*H	: HEATER	RC	: RECEIVER
F*U, FU* (FOR CHARACTERISTICS REFER TO PCB INSIDE YOUR UNIT)	: FUSE	S*C	: LIMIT SWITCH
FG*	: CONNECTOR (FRAME GROUND)	S*L	: FLOAT SWITCH
H*	: HARNESS	S*NPH	: PRESSURE SENSOR (HIGH)
H*P, LED*, V*L	: PILOT LAMP, LIGHT EMITTING DIODE	S*NPL	: PRESSURE SENSOR (LOW)
HAP	: LIGHT EMITTING DIODE (SERVICE MONITOR GREEN)	S*PH, HPS*	: PRESSURE SWITCH (HIGH)
HIGH VOLTAGE	: HIGH VOLTAGE	S*PL	: PRESSURE SWITCH (LOW)
IES	: INTELLIGENT EYE SENSOR	S*T	: THERMOSTAT
IPM*	: INTELLIGENT POWER MODULE	S*W, SW*	: OPERATION SWITCH
K*R, KCR, KFR, KHuR	: MAGNETIC RELAY	SA*	: SURGE ARRESTOR
L	: LIVE	SR*, WLU	: SIGNAL RECEIVER
L*	: COIL	SS*	: SELECTOR SWITCH
L*R	: REACTOR	SHEET METAL	: TERMINAL STRIP FIXED PLATE
M*	: STEPPER MOTOR	T*R	: TRANSFORMER
M*C	: COMPRESSOR MOTOR	TC, TRC	: TRANSMITTER
M*F	: FAN MOTOR	V*, R*V	: VARISTOR
M*P	: DRAIN PUMP MOTOR	V*R	: DIODE BRIDGE
M*S	: SWING MOTOR	WRC	: WIRELESS REMOTE CONTROLLER
MR*, MRCW*, MRM*, MRN*	: MAGNETIC RELAY	X*	: TERMINAL
N	: NEUTRAL	X*M	: TERMINAL STRIP (BLOCK)
n=*	: NUMBER OF PASSES THROUGH FERRITE CORE	Y*E	: ELECTRONIC EXPANSION VALVE COIL
PAM	: PULSE-AMPLITUDE MODULATION	Y*R, Y*S	: REVERSING SOLENOID VALVE COIL
PCB*	: PRINTED CIRCUIT BOARD	Z*C	: FERRITE CORE
PM*	: POWER MODULE	ZF, Z*F	: NOISE FILTER

**For the user**

**10 About the system**

The indoor unit of this split system air conditioner can be used for heating/cooling applications.



**NOTICE**

Do not use the system for other purposes. In order to avoid any quality deterioration, do not use the unit for cooling precision instruments, food, plants, animals or works of art.



**NOTICE**

For future modifications or expansions of your system:  
A full overview of allowable combinations (for future system extensions) is available in technical engineering data and should be consulted. Contact your installer to receive more information and professional advice.

**10.1 System layout**

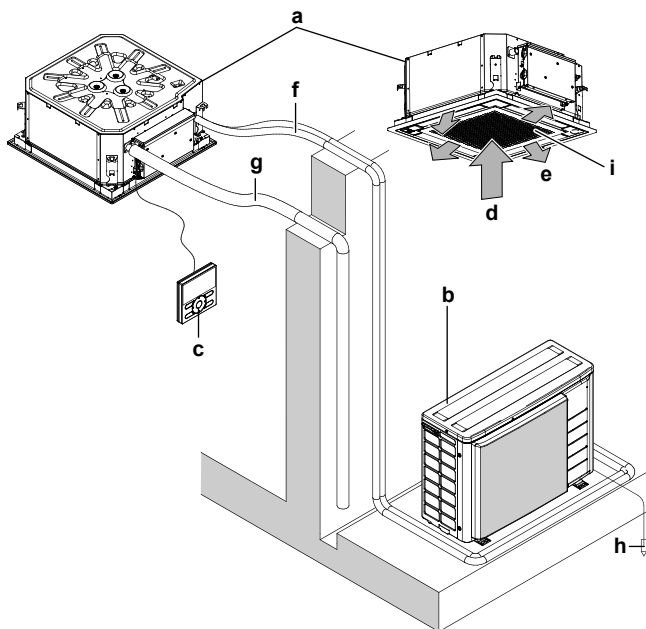

- a Indoor unit
- b Outdoor unit
- c User interface
- d Suction air
- e Discharge air
- f Refrigerant piping + interconnection cable
- g Drain pipe
- h Earth wiring
- i Suction grille and air filter

**11 User interface**



**CAUTION**

Never touch the internal parts of the controller.  
Do not remove the front panel. Some parts inside are dangerous to touch and appliance problems may happen. For checking and adjusting the internal parts, contact your dealer.

This operation manual will give a non-exhaustive overview of the main functions of the system.

For more information about the user interface, see the operation manual of the installed user interface.

**12 Operation**

**12.1 Operation range**

Use the system in the following temperature and humidity ranges for safe and effective operation.

For combination with R410A outdoor unit, refer to the following table:

Outdoor units		Cooling	Heating
RR71~125	Outdoor temperature	-15~46°C DB	—
	Indoor temperature	18~37°C DB 12~28°C WB	—
RQ71~125	Outdoor temperature	-5~46°C DB	-9~21°C DB -10~15°C WB
	Indoor temperature	18~37°C DB 12~28°C WB	10~27°C DB
RXS25~60	Outdoor temperature	-10~46°C DB	-15~24°C DB -16~18°C WB
	Indoor temperature	18~32°C DB	10~30°C DB
2MXS50	Outdoor temperature	10~46°C DB	-15~24°C DB -16~18°C WB
	Indoor temperature	18~32°C DB	10~30°C DB
3MXS40~68 4MXS68~80 5MXS90	Outdoor temperature	-10~46°C DB	-15~24°C DB -16~18°C WB
	Indoor temperature	18~32°C DB	10~30°C DB
RZQG71~140	Outdoor temperature	-15~50°C DB	-19~21°C DB -20~15.5°C WB
	Indoor temperature	18~37°C DB 12~28°C WB	10~27°C DB
RZQSG71~140	Outdoor temperature	-15~46°C DB	-14~21°C DB -15~15.5°C WB
	Indoor temperature	20~37°C DB 14~28°C WB	10~27°C DB
RZQ200~250	Outdoor temperature	-5~46°C DB	-14~21°C DB -15~15°C WB
	Indoor temperature	20~37°C DB 14~28°C WB	10~27°C DB

For combination with R32 outdoor unit, refer to the following table:

Outdoor units		Cooling	Heating
RXM25~60	Outdoor temperature	-10~46°C DB	-15~24°C DB -16~18°C WB
	Indoor temperature	18~32°C DB	10~30°C DB

## 12 Operation

Outdoor units		Cooling	Heating
2MXM50	Outdoor temperature	-10~46°C DB	-15~24°C DB
3MXM40~68			-16~18°C WB
4MXM68~80	Indoor temperature	18~32°C DB	10~30°C DB
5MXM90			
RZAG71~140	Outdoor temperature	-20~52°C DB	-19.5~21°C DB
			-20~15.5°C WB
	Indoor temperature	18~37°C DB	10~27°C DB
		12~28°C WB	
RZASG71~140	Outdoor temperature	-15~46°C DB	-14~21°C DB
			-15~15.5°C WB
	Indoor temperature	20~37°C DB	10~27°C DB
		14~28°C WB	
Indoor humidity		≤80% <sup>(a)</sup>	

(a) To avoid condensation and water dripping out of the unit. If the temperature or the humidity is beyond these conditions, safety devices may be put in action and the air conditioner may not operate.

## 12.2 Operating the system

### 12.2.1 About operating the system

- To protect the unit, turn on the main power switch 6 hours before operation.
- If the main power supply is turned off during operation, operation will restart automatically after the power turns back on again.

### 12.2.2 About cooling, heating, fan only, and automatic operation

- The air flow rate may adjust itself depending on the room temperature or the fan may stop immediately. This is not a malfunction.

### 12.2.3 About the heating operation

It may take longer to reach the set temperature for general heating operation than for cooling operation.

The following operation is performed in order to prevent the heating capacity from dropping or cold air from blowing.

#### Defrost operation

In heating operation, freezing of the outdoor unit's air cooled coil increases over time, restricting the energy transfer to the outdoor unit's coil. Heating capability decreases and the system needs to go into defrost operation to be able to deliver enough heat to the indoor units.

The indoor unit will stop fan operation, the refrigerant cycle will reverse and energy from inside the building will be used to defrost the outdoor unit coil.

The indoor unit will indicate defrost operation on the display .

#### Hot start

In order to prevent cold air from blowing out of an indoor unit at the start of heating operation, the indoor fan is automatically stopped. The display of the user interface shows . It may take some time before the fan starts. This is not a malfunction.

### 12.2.4 To operate the system

- Press the operation mode selector button on the user interface several times and select the operation mode of your choice.

 Cooling operation

 Heating operation

 Fan only operation

- Press the ON/OFF button on the user interface.

**Result:** The operation lamp lights up and the system starts operating.

## 12.3 Using the dry program

### 12.3.1 About the dry program

- The function of this program is to decrease the humidity in your room with minimal temperature decrease (minimal room cooling).
- The micro computer automatically determines temperature and fan speed (cannot be set by the user interface).
- The system does not go into operation if the room temperature is low (<20°C).

### 12.3.2 To use the dry program

#### To start

- Press the operation mode selector button on the user interface several times and select  (program dry operation).
- Press the ON/OFF button of the user interface.

**Result:** The operation lamp lights up and the system starts operating.

#### To stop

- Press the ON/OFF button on the user interface once again.

**Result:** The operation lamp goes out and the system stops operating.



#### NOTICE

Do not turn off power immediately after the unit stops, but wait for at least 5 minutes.

## 12.4 Adjusting the air flow direction

Refer to the operation manual of the user interface.

### 12.4.1 About the air flow flap





Double flow+multi-flow units

For the following conditions, a micro computer controls the air flow direction which may be different from the display.

Cooling	Heating
<ul style="list-style-type: none"> <li>When the room temperature is lower than the set temperature.</li> </ul>	<ul style="list-style-type: none"> <li>When starting operation.</li> <li>When the room temperature is higher than the set temperature.</li> <li>At defrost operation.</li> </ul>
<ul style="list-style-type: none"> <li>When operating continuously at horizontal air flow direction.</li> <li>When continuous operation with downward air flow is performed at the time of cooling with a ceiling-suspended or a wall-mounted unit, the micro computer may control the flow direction, and then the user interface indication will also change.</li> </ul>	

The air flow direction can be adjusted in one of the following ways:

- The air flow flap itself adjusts its position.
- The air flow direction can be fixed by the user.
- Automatic  and desired position .





## WARNING

Never touch the air outlet or the horizontal blades while the swing flap is in operation. Fingers may become caught or the unit may break down.



## NOTICE

- The movable limit of the flap is changeable. Contact your dealer for details. (only for double-flow, multi-flow, corner, ceiling-suspended and wall-mounted).
- Avoid operating in the horizontal direction . It may cause dew or dust to settle on the ceiling or flap.

## 13 Maintenance and service



## NOTICE

Never inspect or service the unit by yourself. Ask a qualified service person to perform this work. However, as end user, you may clean the air filter, suction grille, air outlet and outside panels.



## WARNING

Never replace a fuse with a fuse of a wrong ampere ratings or other wires when a fuse blows out. Use of wire or copper wire may cause the unit to break down or cause a fire.



## CAUTION

Do not insert fingers, rods or other objects into the air inlet or outlet. Do not remove the fan guard. When the fan is rotating at high speed, it will cause injury.



## CAUTION

After a long use, check the unit stand and fitting for damage. If damaged, the unit may fall and result in injury.



## NOTICE

Do not wipe the controller operation panel with benzine, thinner, chemical dust cloth, etc. The panel may get discoloured or the coating peeled off. If it is heavily dirty, soak a cloth in water-diluted neutral detergent, squeeze it well and wipe the panel clean. Wipe it with another dry cloth.



## CAUTION

Before accessing terminal devices, make sure to interrupt all power supply.



## NOTICE

When cleaning the heat exchanger, make sure to remove the switch box, fan motor, drain pump and float switch. Water or detergent might deteriorate the insulation of electronic components and result in burnout of these components.

### 13.1 Cleaning the air filter, suction grille, air outlet and outside panels

#### 13.1.1 To clean the air filter

When to clean the air filter:

- Rule of thumb: Clean every 6 months. If the air in the room is extremely contaminated, increase the cleaning frequency.

- Depending on the settings, the user interface can display the **TIME TO CLEAN AIR FILTER** notification. Clean the air filter when the notification is displayed.
- If the dirt becomes impossible to clean, change the air filter (= optional equipment).

How to clean the air filter:



## NOTICE

Do NOT use water of 50°C or higher. **Possible consequence:** Discoloration and deformation.

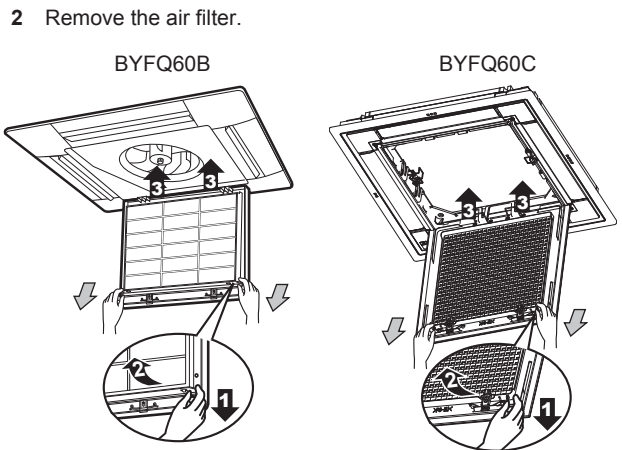
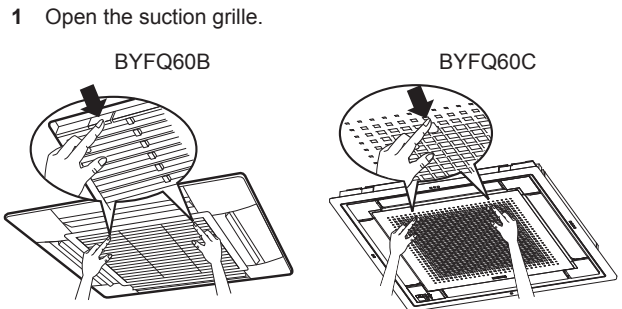

- Clean the air filter. Use a vacuum cleaner or wash with water. If the air filter is very dirty, use a soft brush and neutral detergent.

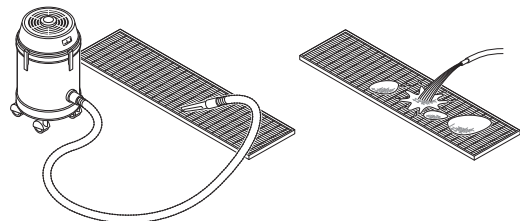

- Dry the air filter in the shadow.
- Reattach the air filter and close the suction grille (steps 2 and 1 in reverse order).
- Turn ON the power.
- Press the **FILTER SIGN RESET** button.

**Result:** The **TIME TO CLEAN AIR FILTER** notification disappears from the user interface.

#### 13.1.2 To clean the suction grille



## NOTICE

Do NOT use water of 50°C or higher. **Possible consequence:** Discoloration and deformation.

- Open the suction grille.

BYFQ60B

BYFQ60C

## 13 Maintenance and service

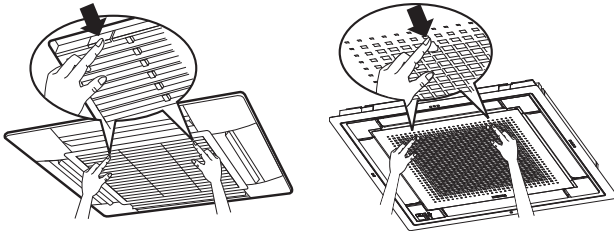

2 Remove the suction grille.

BYFQ60B

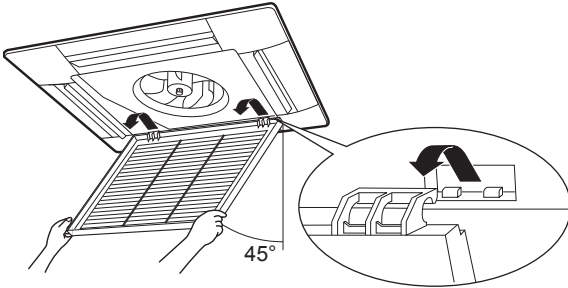

BYFQ60C

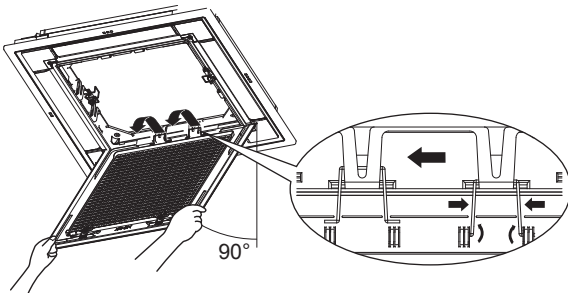

3 Remove the air filter.

BYFQ60B

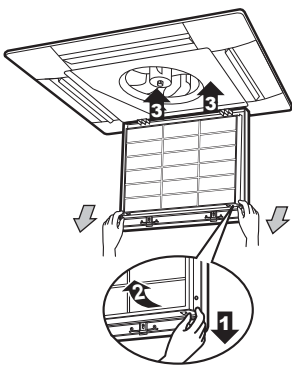

BYFQ60C

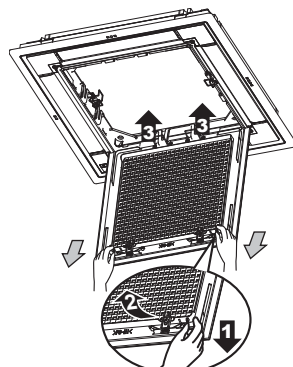

- 4 Clean the suction grille. Wash with a soft bristle brush and water or neutral detergent. If the suction grille is very dirty, use a typical kitchen cleaner, leave it on for 10 min, then wash it with water.
- 5 Reattach the air filter (step 3 in reverse order).
- 6 Reattach the suction grille and close it. (step 2 and 1 in reverse order)

### 13.1.3 To clean the air outlet and outside panels



#### WARNING

Do NOT let the indoor unit get wet. **Possible consequence:** Electric shock or fire.



#### NOTICE

- Do NOT use gasoline, benzene, thinner polishing powder or liquid insecticide. **Possible consequence:** Discoloration and deformation.
- Do NOT use water or air of 50°C or higher. **Possible consequence:** Discoloration and deformation.
- Do NOT scrub firmly when washing the blade with water. **Possible consequence:** The surface sealing peels off.

Clean with a soft cloth. If it is difficult to remove stains, use water or neutral detergent.

### 13.2 Maintenance after a long stop period

E.g., at the beginning of the season.

- Check and remove everything that might be blocking inlet and outlet vents of indoor units and outdoor units.
- Clean air filters and casings of indoor units (see "13.1.1 To clean the air filter" on page 17 and "13.1.3 To clean the air outlet and outside panels" on page 18).
- Turn on the power at least 6 hours before operating the unit in order to ensure smoother operation. As soon as the power is turned on, the user interface display appears.

### 13.3 Maintenance before a long stop period

E.g., at the end of the season.

- Let the indoor units run in fan only operation for about half a day in order to dry the interior of the units. Refer to "12.2.2 About cooling, heating, fan only, and automatic operation" on page 16 for details on fan only operation.
- Turn off the power. The user interface display disappears.
- Clean air filters and casings of indoor units (see "13.1.1 To clean the air filter" on page 17 and "13.1.3 To clean the air outlet and outside panels" on page 18).

### 13.4 About the refrigerant

This product contains fluorinated greenhouse gases. Do NOT vent gases into the atmosphere.

Refrigerant type: R32

Global warming potential (GWP) value: 675

Refrigerant type: R410A

Global warming potential (GWP) value: 2087.5



#### NOTICE

In Europe, the **greenhouse gas emissions** of the total refrigerant charge in the system (expressed as tonnes CO<sub>2</sub>-equivalent) is used to determine the maintenance intervals. Follow the applicable legislation.

**Formula to calculate the greenhouse gas emissions:**  
GWP value of the refrigerant × Total refrigerant charge [in kg] / 1000

Please contact your installer for more information.



#### WARNING: FLAMMABLE MATERIAL

The R32 refrigerant (if applicable) in this unit is mildly flammable.<sup>(a)</sup>

- (a) Refer to the outdoor unit specifications for the type of refrigerant to be used.

**WARNING**

- Do NOT pierce or burn refrigerant cycle parts.
- Do NOT use cleaning materials or means to accelerate the defrosting process other than those recommended by the manufacturer.
- Be aware that the refrigerant inside the system is odourless.

**WARNING**

R410A is a non-combustible refrigerant, and R32 is a mildly flammable refrigerant; they normally don't leak. If the refrigerant leaks in the room and comes in contact with fire from a burner, a heater, or a cooker, this may result in a fire (in case of R32), or the formation of a harmful gas.

Turn off any combustible heating devices, ventilate the room, and contact the dealer from where you purchased the unit.

Do not use the unit until a service person confirms that the part from which the refrigerant leaked has been repaired.

### 13.5 After-sales service and warranty

#### 13.5.1 Warranty period

- This product includes a warranty card that was filled in by the dealer at the time of installation. The completed card has to be checked by the customer and stored carefully.
- If repairs to the product are necessary within the warranty period, contact your dealer and keep the warranty card at hand.

#### 13.5.2 Recommended maintenance and inspection

Since dust collects when using the unit for several years, performance of the unit will deteriorate to some extent. As taking apart and cleaning interiors of units requires technical expertise and in order to ensure the best possible maintenance of your units, we recommend to enter into a maintenance and inspection contract on top of normal maintenance activities. Our network of dealers has access to a permanent stock of essential components in order to keep your unit in operation as long as possible. Contact your dealer for more information.

**When asking your dealer for an intervention, always state:**

- The complete model name of the unit.
- The manufacturing number (stated on the nameplate of the unit).
- The installation date.
- The symptoms or malfunction, and details of the defect.

**WARNING**

- Do not modify, disassemble, remove, reinstall or repair the unit yourself as incorrect dismantling or installation may cause an electric shock or fire. Contact your dealer.
- In case of accidental refrigerant leaks, make sure there are no naked flames. The refrigerant itself is entirely safe and non-toxic. R410A is a non-combustible refrigerant, and R32 is a mildly flammable refrigerant, but they will generate a toxic gas when they accidentally leak into a room where combustible air from fan heaters, gas cookers, etc. is present. Always have qualified service personnel confirm that the point of leakage has been repaired or corrected before resuming operation.

#### 13.5.3 Recommended maintenance and inspection cycles

Be aware that the mentioned maintenance and replacement cycles do not relate to the warranty period of the components.

Component	Inspection cycle	Maintenance cycle (replacements and/or repairs)
Electric motor	1 year	20,000 hours
PCB		25,000 hours
Heat exchanger		5 years
Sensor (thermistor, etc.)		5 years
User interface and switches		25,000 hours
Drain pan		8 years
Expansion valve		20,000 hours
Solenoid valve		20,000 hours

The table assumes the following conditions of use:

- Normal use without frequent starting and stopping of the unit. Depending on the model, we recommend not starting and stopping the machine more than 6 times/hour.
- Operation of the unit is assumed to be 10 hours/day and 2,500 hours/year.



**NOTICE**

- The table indicates main components. Refer to your maintenance and inspection contract for more details.
- The table indicates recommended intervals of maintenance cycles. However, in order to keep the unit operational as long as possible, maintenance work may be required sooner. Recommended intervals can be used for appropriate maintenance design in terms of budgeting maintenance and inspection fees. Depending on the content of the maintenance and inspection contract, inspection and maintenance cycles may in reality be shorter than listed.

#### 13.5.4 Shortened maintenance and replacement cycles

Shortening of "maintenance cycle" and "replacement cycle" needs to be considered in following situations:

**The unit is used in locations where:**

- Heat and humidity fluctuate out of the ordinary.
- Power fluctuation is high (voltage, frequency, wave distortion, etc.) (the unit cannot be used if power fluctuation is outside the allowable range).
- Bumps and vibrations are frequent.
- Dust, salt, harmful gas or oil mist such as sulphurous acid and hydrogen sulfide may be present in the air.
- The machine is started and stopped frequently or operation time is long (sites with 24 hour air-conditioning).

**Recommended replacement cycle of wear parts**

Component	Inspection cycle	Maintenance cycle (replacements and/or repairs)
Air filter	1 year	5 years
High efficiency filter		1 year
Fuse		10 years
Pressure containing parts		In case of corrosion, contact your local dealer.

# 14 Troubleshooting

## NOTICE

- The table indicates main components. Refer to your maintenance and inspection contract for more details.
- The table indicates recommended intervals of replacement cycles. However, in order to keep the unit operational as long as possible, maintenance work may be required sooner. Recommended intervals can be used for appropriate maintenance design in terms of budgeting maintenance and inspection fees. Contact your dealer for details.

## INFORMATION

Damage due to taking apart or cleaning interiors of units by anyone other than our authorised dealers may not be included in the warranty.

# 14 Troubleshooting

If one of the following malfunctions occur, take the measures shown below and contact your dealer.

## WARNING

**Stop operation and shut off the power if anything unusual occurs (burning smells etc.).**

Leaving the unit running under such circumstances may cause breakage, electric shock or fire. Contact your dealer.

The system must be repaired by a qualified service person:

Malfunction	Measure
If a safety device such as a fuse, a breaker or an earth leakage breaker frequently actuates or the ON/OFF switch does not properly work.	Turn off the main power switch.
If water leaks from the unit.	Stop the operation.
The operation switch does not work well.	Turn off the power.
If the user interface display indicates the unit number, the operation lamp flashes and the malfunction code appears.	Notify your installer and report the malfunction code.

If the system does not properly operate except for the above mentioned cases and none of the above mentioned malfunctions is evident, investigate the system according to the following procedures.

Malfunction	Measure
If the system does not operate at all.	<ul style="list-style-type: none"> <li>▪ Check if there is no power failure. Wait until power is restored. If power failure occurs during operation, the system automatically restarts immediately after power is restored.</li> <li>▪ Check if no fuse has blown or breaker is activated. Change the fuse or reset the breaker if necessary.</li> </ul>

Malfunction	Measure
The system operates but cooling or heating is insufficient.	<ul style="list-style-type: none"> <li>▪ Check if air inlet or outlet of outdoor or indoor unit is not blocked by obstacles. Remove any obstacles and make sure the air can flow freely.</li> <li>▪ Check if the air filter is not clogged (see "13.1.1 To clean the air filter" on page 17).</li> <li>▪ Check the temperature setting.</li> <li>▪ Check the fan speed setting on your user interface.</li> <li>▪ Check for open doors or windows. Close doors and windows to prevent wind from coming in.</li> <li>▪ Check if there are too many occupants in the room during cooling operation. Check if the heat source of the room is excessive.</li> <li>▪ Check if direct sunlight enters the room. Use curtains or blinds.</li> <li>▪ Check if the air flow angle is proper.</li> </ul>

If after checking all above items, it is impossible to fix the problem yourself, contact your installer and state the symptoms, the complete model name of the unit (with manufacturing number if possible) and the installation date (possibly listed on the warranty card).

## 14.1 Symptoms that are NOT system malfunctions

The following symptoms are NOT system malfunctions:

### 14.1.1 Symptom: The system does not operate

- The air conditioner does not start immediately after the ON/OFF button on the user interface is pressed. If the operation lamp lights, the system is in normal condition. To prevent overloading of the compressor motor, the air conditioner starts 5 minutes after it is turned ON again in case it was turned OFF just before. The same starting delay occurs after the operation mode selector button was used.
- If "Under Centralized Control" is displayed on the user interface, pressing the operation button causes the display to blink for a few seconds. The blinking display indicates that the user interface cannot be used.
- The system does not start immediately after the power supply is turned on. Wait one minute until the micro computer is prepared for operation.

### 14.1.2 Symptom: The fan strength does not correspond to the setting

The fan speed does not change even if the fan speed adjustment button is pressed. During heating operation, when the room temperature reaches the set temperature, the outdoor unit goes off and the indoor unit changes to whisper fan speed. This is to prevent cold air blowing directly on occupants of the room. The fan speed will not change if the button is pressed.

### 14.1.3 Symptom: The fan direction does not correspond to the setting

The fan direction does not correspond with the user interface display. The fan direction does not swing. This is because the unit is being controlled by the micro computer.

**14.1.4 Symptom: White mist comes out of a unit (Indoor unit)**

- When humidity is high during cooling operation. If the interior of an indoor unit is extremely contaminated, the temperature distribution inside a room becomes uneven. It is necessary to clean the interior of the indoor unit. Ask your dealer for details on cleaning the unit. This operation requires a qualified service person.
- Immediately after the cooling operation stops and if the room temperature and humidity are low. This is because warm refrigerant gas flows back into the indoor unit and generates steam.

**14.1.5 Symptom: White mist comes out of a unit (Indoor unit, outdoor unit)**

When the system is changed over to heating operation after defrost operation. Moisture generated by defrost becomes steam and is exhausted.

**14.1.6 Symptom: The user interface display reads "U4" or "U5" and stops, but then restarts after a few minutes**

This is because the user interface is intercepting noise from electric appliances other than the air conditioner. The noise prevents communication between the units, causing them to stop. Operation automatically restarts when the noise ceases.

**14.1.7 Symptom: Noise of air conditioners (Indoor unit)**

- A "zeen" sound is heard immediately after the power supply is turned on. The electronic expansion valve inside an indoor unit starts working and makes the noise. Its volume will reduce in about one minute.
- A continuous low "shah" sound is heard when the system is in cooling operation or at a stop. When the drain pump is in operation, this noise is heard.
- A "pishi-pishi" squeaking sound is heard when the system stops after heating operation. Expansion and contraction of plastic parts caused by temperature change make this noise.

**14.1.8 Symptom: Noise of air conditioners (Indoor unit, outdoor unit)**

- A continuous low hissing sound is heard when the system is in cooling or defrost operation. This is the sound of refrigerant gas flowing through both indoor and outdoor units.
- A hissing sound which is heard at the start or immediately after stopping operation or defrost operation. This is the noise of refrigerant caused by flow stop or flow change.

**14.1.9 Symptom: Noise of air conditioners (Outdoor unit)**

When the tone of operating noise changes. This noise is caused by the change of frequency.

**14.1.10 Symptom: Dust comes out of the unit**

When the unit is used for the first time in a long time. This is because dust has gotten into the unit.

**14.1.11 Symptom: The units can give off odours**

The unit can absorb the smell of rooms, furniture, cigarettes, etc., and then emit it again.

**14.1.12 Symptom: The outdoor unit fan does not spin**

During operation. The speed of the fan is controlled in order to optimise product operation.

**14.1.13 Symptom: The display shows "88"**

This is the case immediately after the main power supply switch is turned on and means that the user interface is in normal condition. This continues for 1 minute.

**14.1.14 Symptom: The compressor in the outdoor unit does not stop after a short heating operation**

This is to prevent refrigerant from remaining in the compressor. The unit will stop after 5 to 10 minutes.

## 15 Relocation

Contact your dealer for removing and reinstalling the total unit. Moving units requires technical expertise.

## 16 Disposal

This unit uses hydrofluorocarbon. Contact your dealer when discarding this unit.

**NOTICE**

Do not try to dismantle the system yourself: the dismantling of the system, treatment of the refrigerant, oil and other parts must comply with applicable legislation. Units must be treated at a specialized treatment facility for reuse, recycling and recovery.

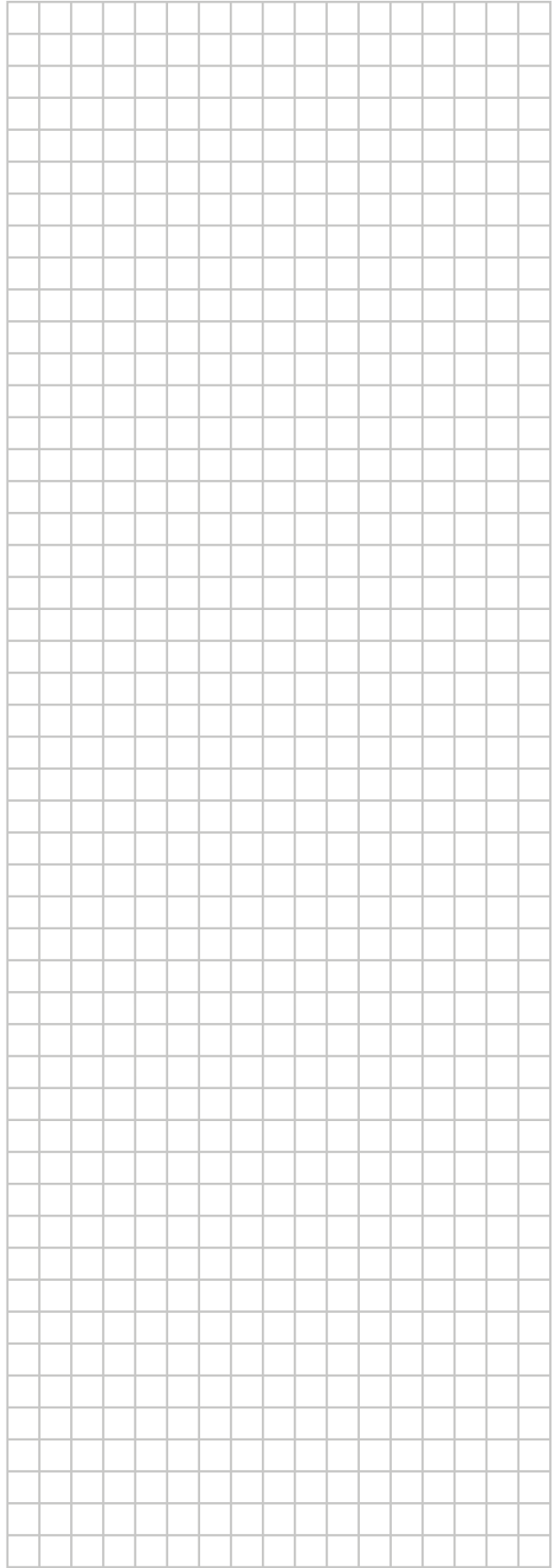
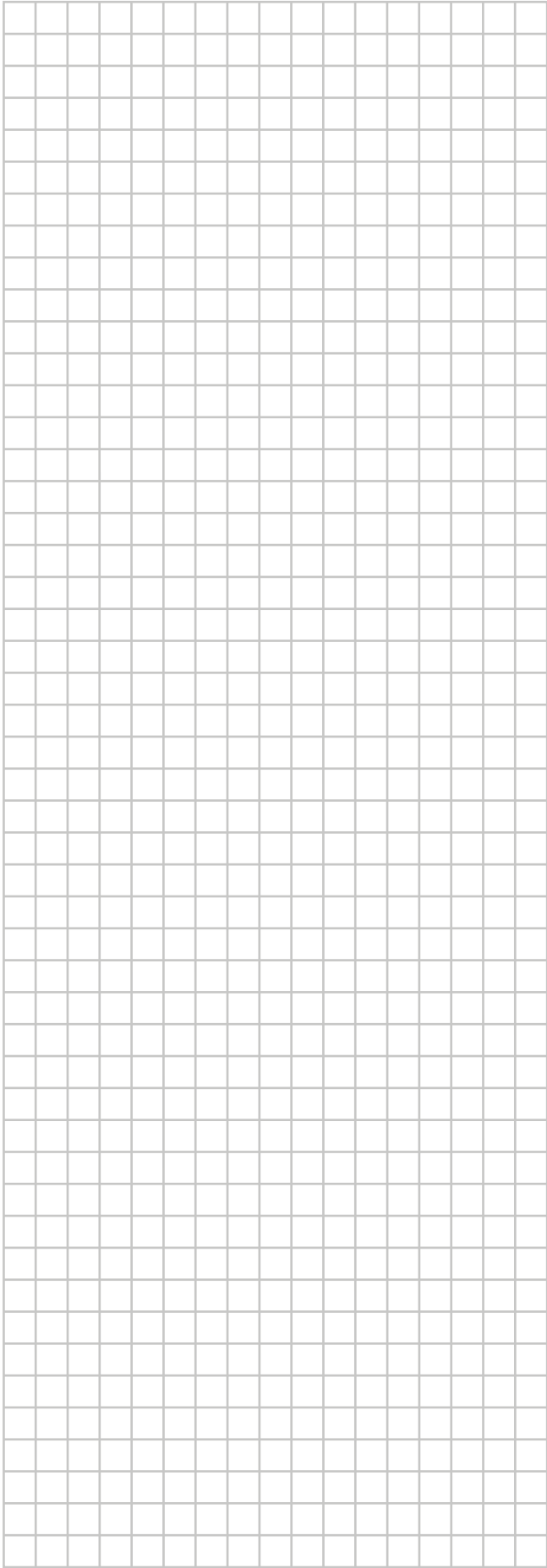

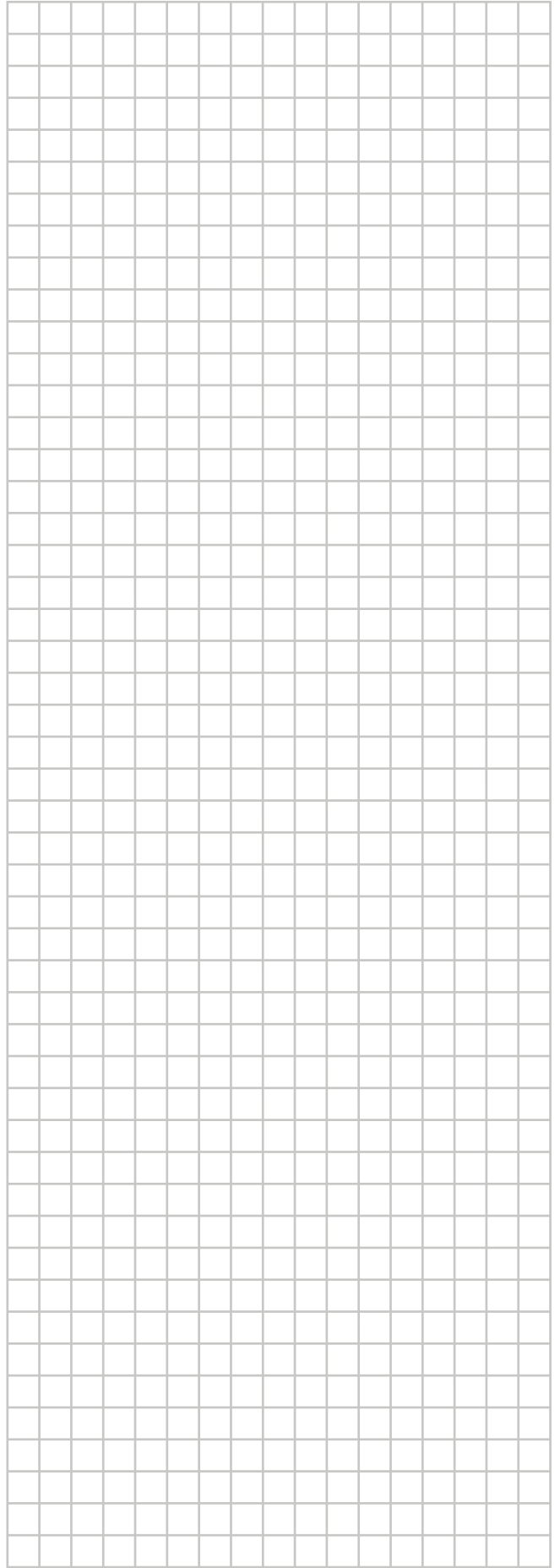
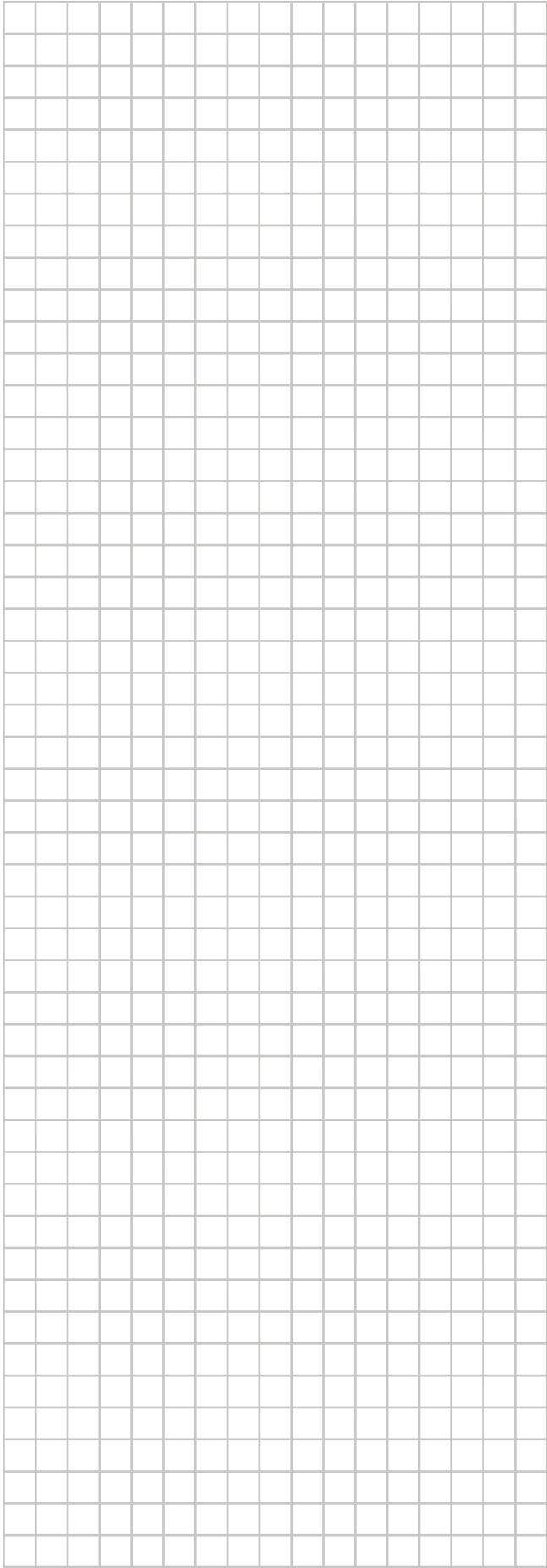

ERC



**DAIKIN INDUSTRIES CZECH REPUBLIC s.r.o.**

U Nové Hospody 1/1155, 301 00 Plzeň Skvrňany, Czech Republic

**DAIKIN EUROPE N.V.**

Zandvoordestraat 300, B-8400 Oostende, Belgium

Copyright 2017 Daikin

4P456960-1 2017.03